

TOP VIEW

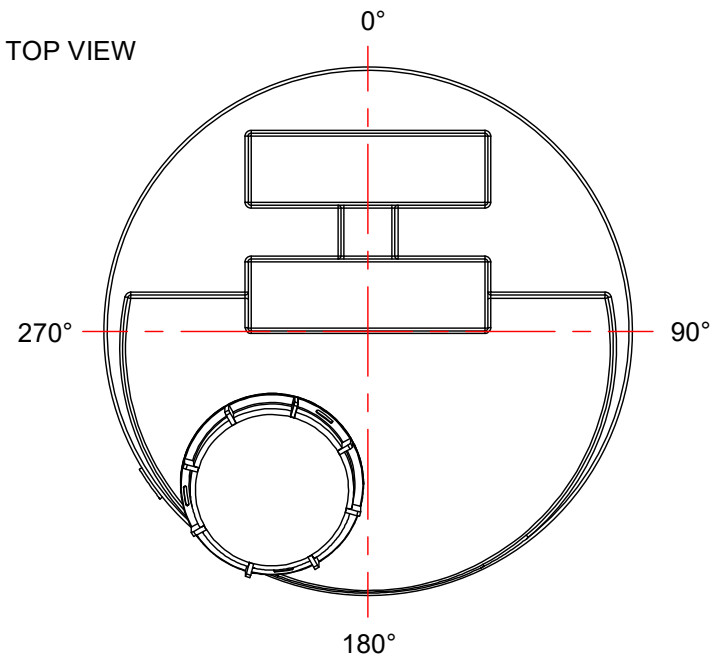

NOTES:

1. TANK IS MANUFACTURED FROM POLYETHYLENE (PE).
2. RATED FOR STORING LIQUIDS WITH A SPECIFIC GRAVITY OF 1.5SG OR LOWER (ALSO AVAILABLE IN 1.9SG & 2.2SG)
3. ALL TANK DIMENSIONS ARE SUBJECT TO A +/-3% TOLERANCE.
4. ALL EXTERNAL PIPING AND ACCESSORIES MUST BE FULLY SUPPORTED AND FLEXIBLE TO AVOID STRESSING THE TANK.

MATERIALS LIST			
ITEMS	PART#	DESCRIPTION	NOTES
A	PTB-200	44 IG / 53 USG / 200L TOTE BARREL	
B		5 1/2" THREADED LID	

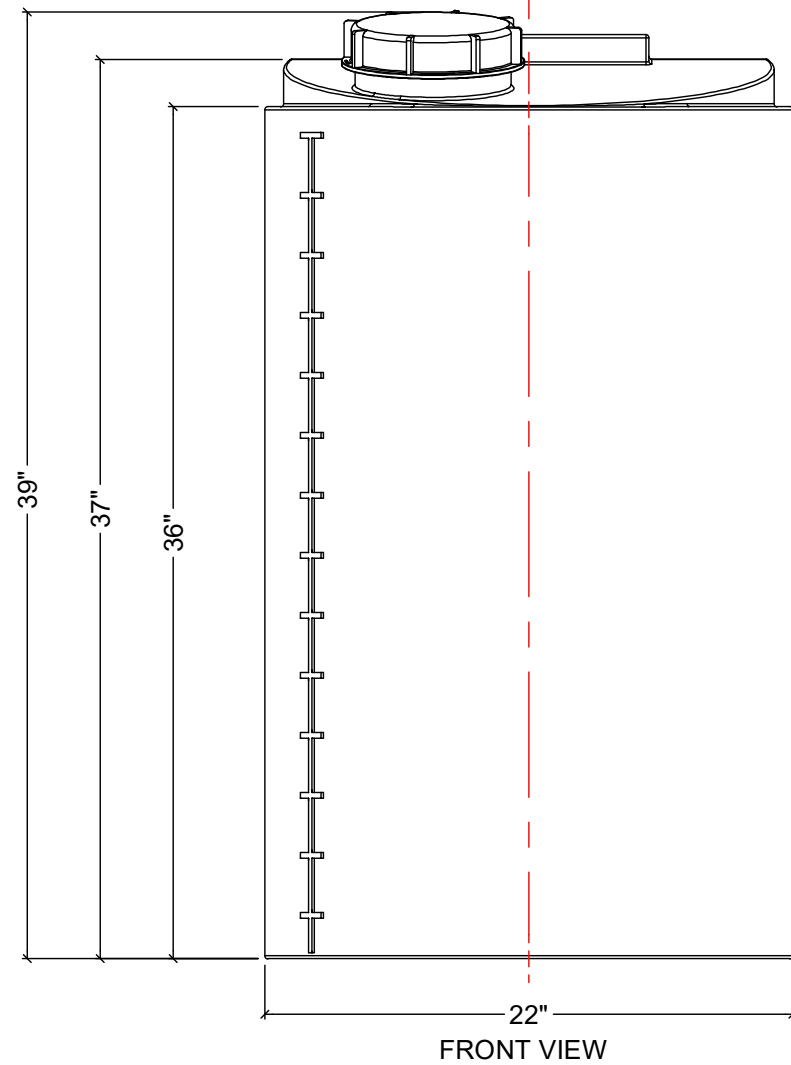

FRONT VIEW

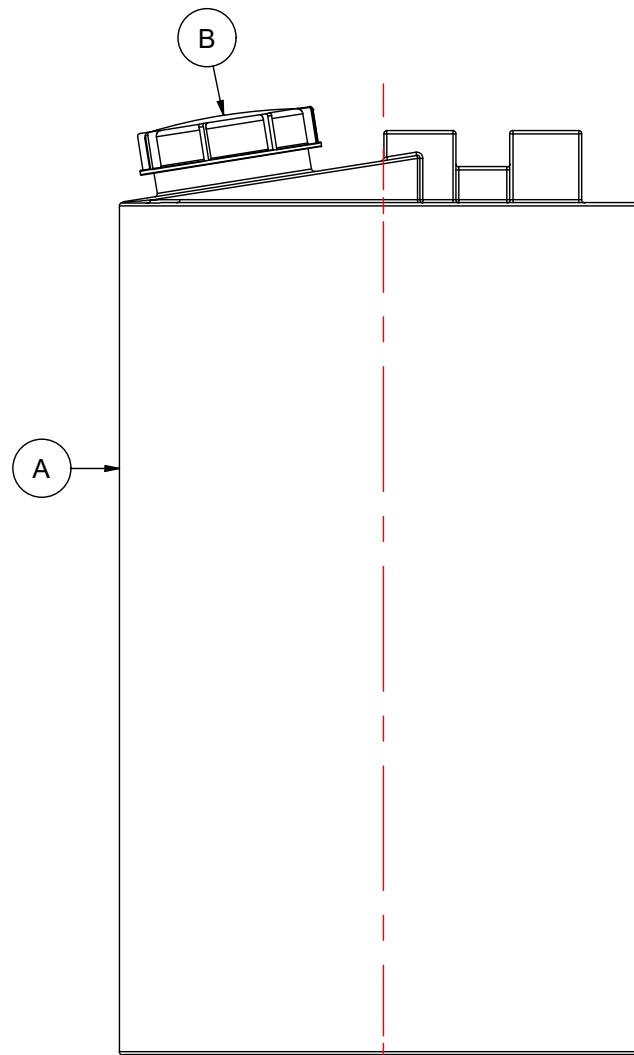

SIDE VIEW

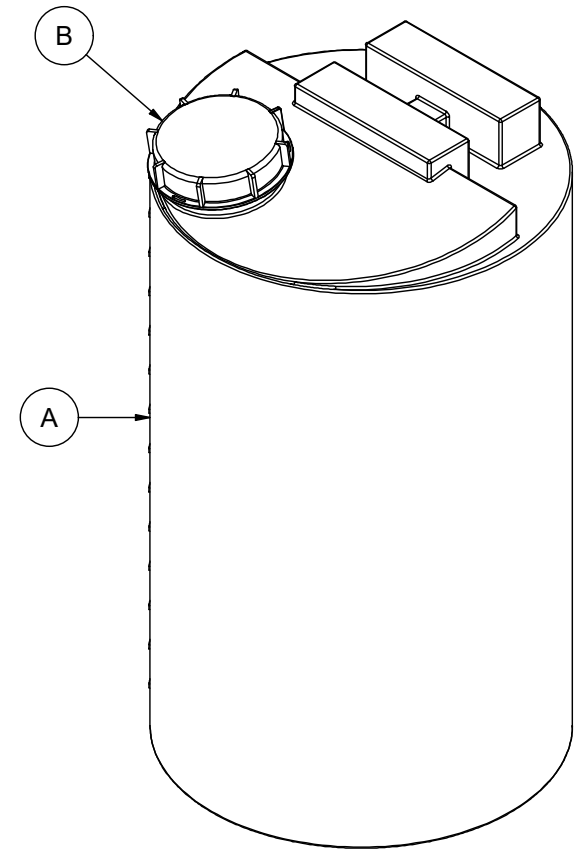

REV	DATE	DESCRIPTION	BY	APPD	REVD
REVISIONS					
CUSTOMER					
TITLE		ACO JOB NO:			
44 IG / 53 USG / 200 L TOTE BARREL		PURCHASE ORDER NO:			
		PURCHASER'S EQUIP. NO:			
THIS DRAWING IS THE PROPERTY OF ROTOPLAST INC. AND SHALL NOT BE COPIED OR TRANSFERRED WITHOUT THE WRITTEN CONSENT OF ROTOPLAST INC.					
ENGINEERS SEAL		ACO CONTAINER SYSTEMS DIVISION OF ROTOPLAST INC.			
<small>PICKERING - ONTARIO - CANADA</small>					
<small>ACO CONTAINER SYSTEMS DIVISION OF ROTOPLAST INC. 794 MCKAY RD. PICKERING, ONTARIO, CANADA TEL. 905-683-8222 FAX 905-683-2969</small>		<small>DESIGNED</small>		<small>DRAWN</small>	<small>gt</small>
		<small>CHECKED</small>		<small>APPROVED</small>	
		<small>SCALE</small>		<small>DATE</small>	<small>N.T.S. 04-16-2024</small>
<small>DWG No</small>		PTB-200-2024			<small>REV</small>
					0