

NOTES:

1. TANK IS MANUFACTURED TO ASTM-D-1998 STANDARD.
2. ALL DIMENSIONS ARE APPROXIMATE.

MATERIALS LIST		
ITEMS	DESCRIPTION	NOTES
A	OT-60 OPEN TOP TANK	
B	LID FOR OT-60	

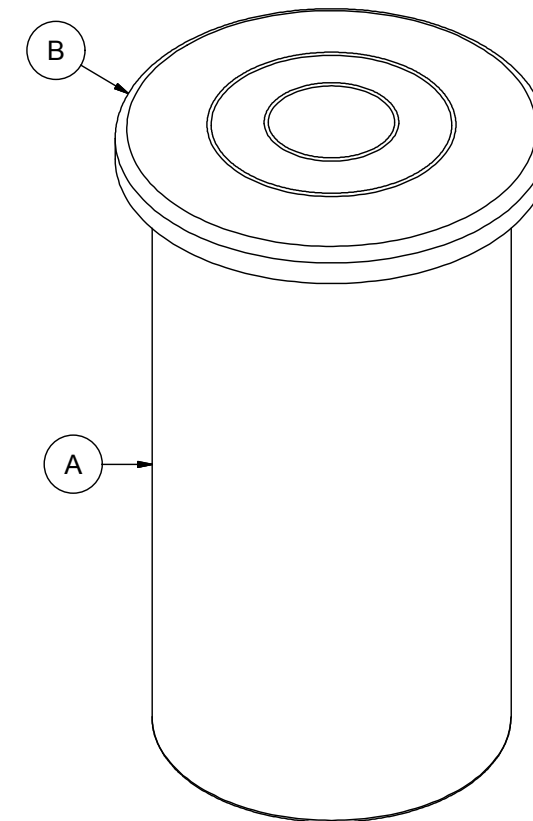

REV	DATE	DESCRIPTION	BY	APPD	REVD
REVISIONS					
CUSTOMER					
TITLE		ACO JOB NO:			
60 IG OPEN TOP TANK		PURCHASE ORDER NO:			
		PURCHASER'S EQUIP. NO:			
THIS DRAWING IS THE PROPERTY OF ROTOPLAST INC. AND SHALL NOT BE COPIED OR TRANSFERRED WITHOUT THE WRITTEN CONSENT OF ROTOPLAST INC.					
ENGINEERS SEAL		<b>ACO CONTAINER SYSTEMS</b> DIVISION OF ROTOPLAST INC. <small>PICKERING - ONTARIO - CANADA</small> ACO CONTAINER SYSTEMS DIVISION OF ROTOPLAST INC. 794 MCKAY RD. PICKERING, ONTARIO, CANADA TEL. 905-683-8222 FAX 905-683-2969 <small>DWG No</small>			
		DESIGNED			
		DRAWN	WM		
		CHECKED			
		APPROVED			
		SCALE		N.T.S.	
		DATE		03-03-16	
		OT-60-L		REV	0