

MATERIALS LIST

ITEMS	DESCRIPTION	NOTES
A	IRD-410 SECONDARY CONTAINMENT BASIN	

NOTES:

1. TANK IS MANUFACTURED FROM HDPE.
2. TANK IS MANUFACTURED TO ASTM-D-1998 STANDARD.
3. TANK CAPACITY: 410 I.G. (1800 L).
4. ALL DIMENSIONS ARE APPROXIMATE.

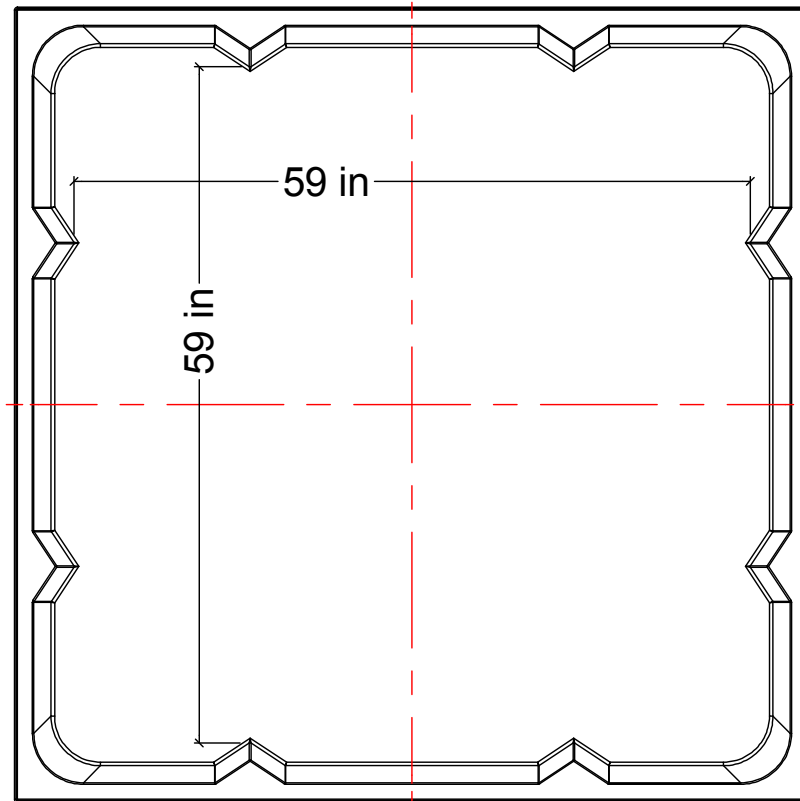

TOP VIEW

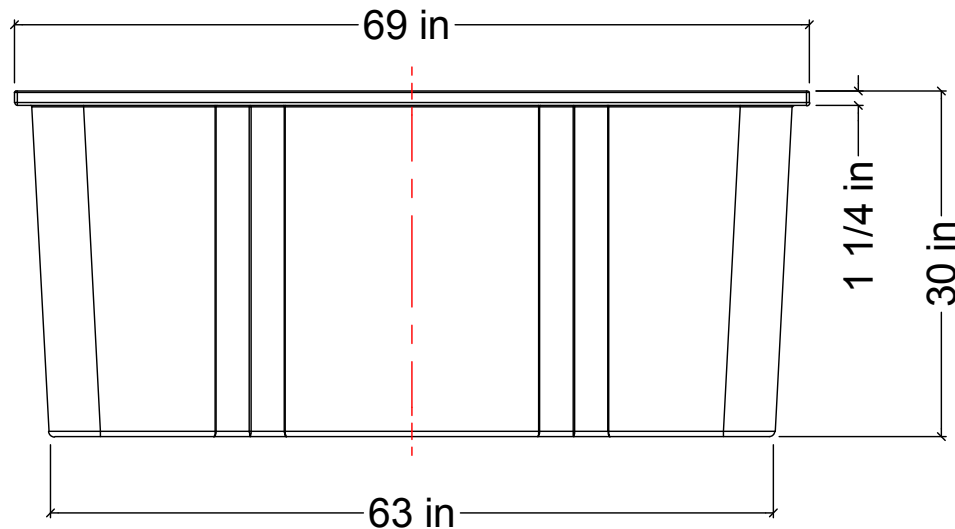
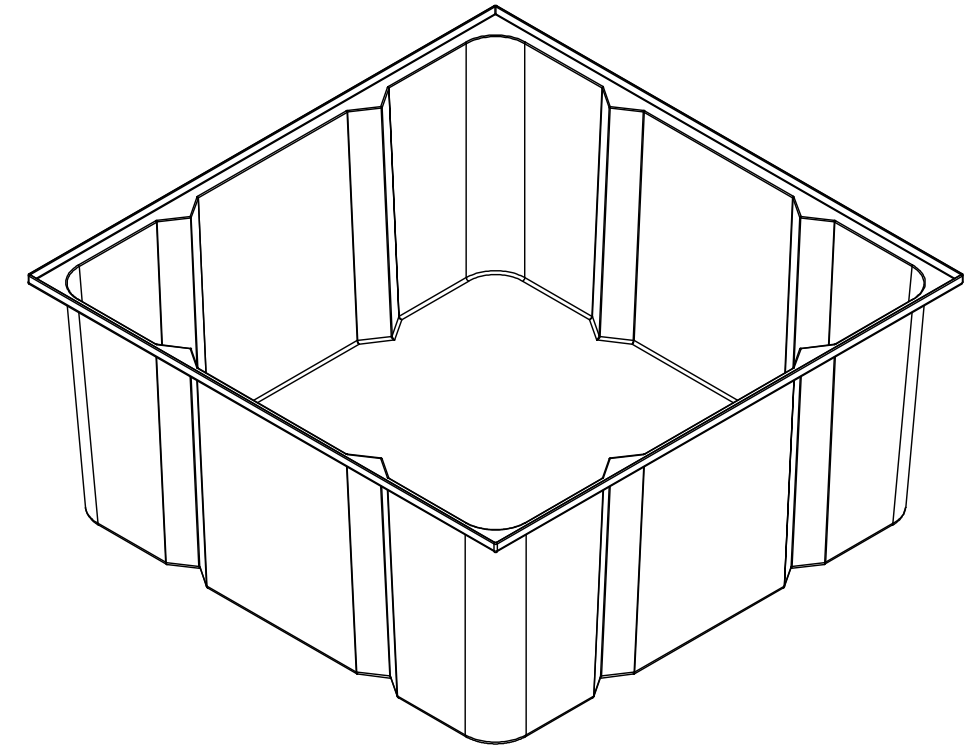

FRONT VIEW

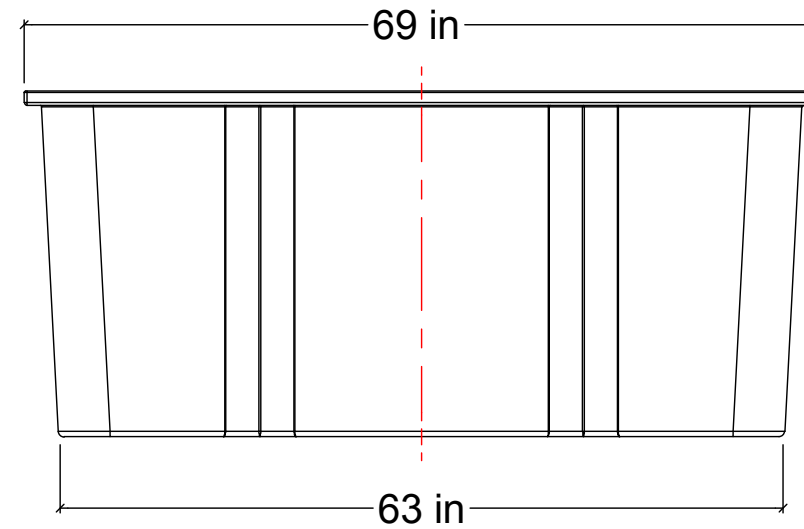

SIDE VIEW

REV	DATE	DESCRIPTION	BY	APPD	REVD
REVISIONS					
CUSTOMER					
TITLE 410 IG SECONDARY CONTAINMENT BASIN			ACO JOB NO: PURCHASE ORDER NO: PURCHASER'S EQUIP. NO:		
THIS DRAWING IS THE PROPERTY OF ROTOPLAST INC. AND SHALL NOT BE COPIED OR TRANSFERRED WITHOUT THE WRITTEN CONSENT OF ROTOPLAST INC.					
ENGINEERS SEAL		ACO CONTAINER SYSTEMS DIVISION OF ROTOPLAST INC.			
<small>PICKERING - ONTARIO - CANADA</small>					
ACO CONTAINER SYSTEMS DIVISION OF ROTOPLAST INC. 794 MCKAY RD. PICKERING, ONTARIO, CANADA TEL. 905-683-8222 FAX 905-683-2969			DESIGNED		
			DRAWN	WM	
			CHECKED		
			APPROVED		
			SCALE	N.T.S.	
			DATE	15-03-16	
DWG No			IRD-410		REV 0