

MATERIALS LIST

ITEMS	DESCRIPTION	NOTES
A	OT-220 OPEN TOP TANK	
B	LID FOR OT-220	

NOTES:

1. TANK IS MANUFACTURED TO ASTM-D-1998 STANDARD.
2. ALL DIMENSIONS ARE APPROXIMATE.

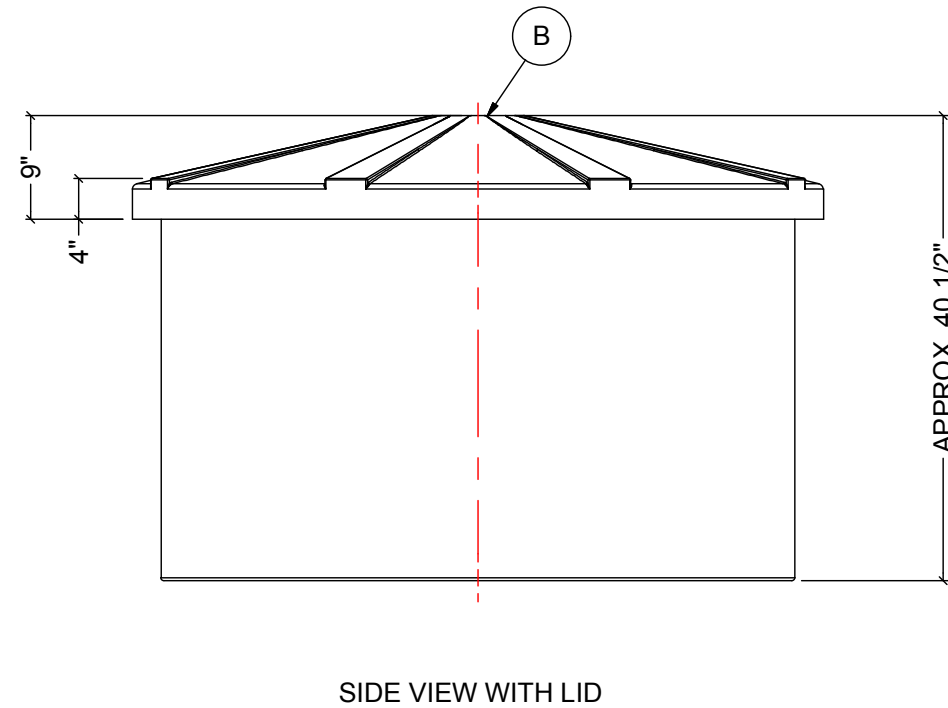
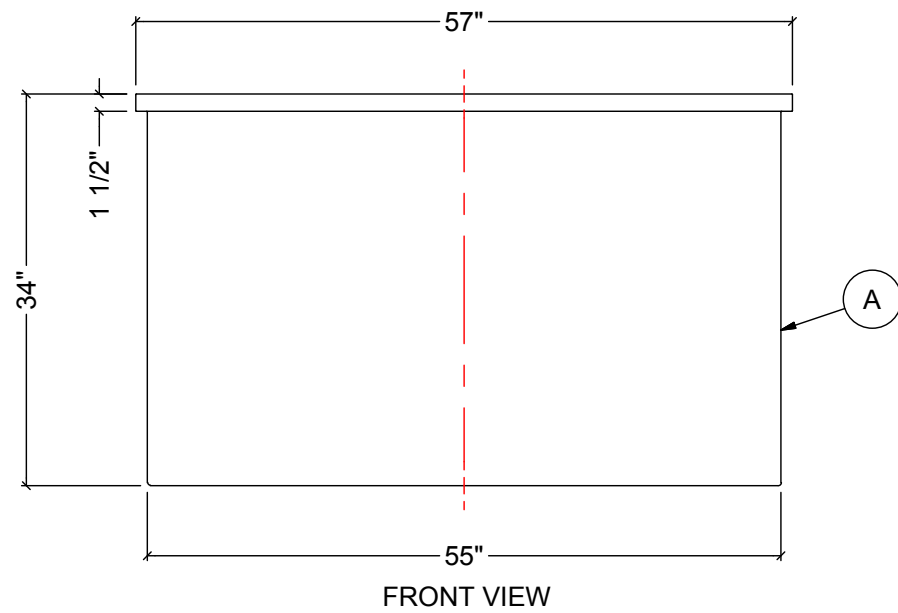
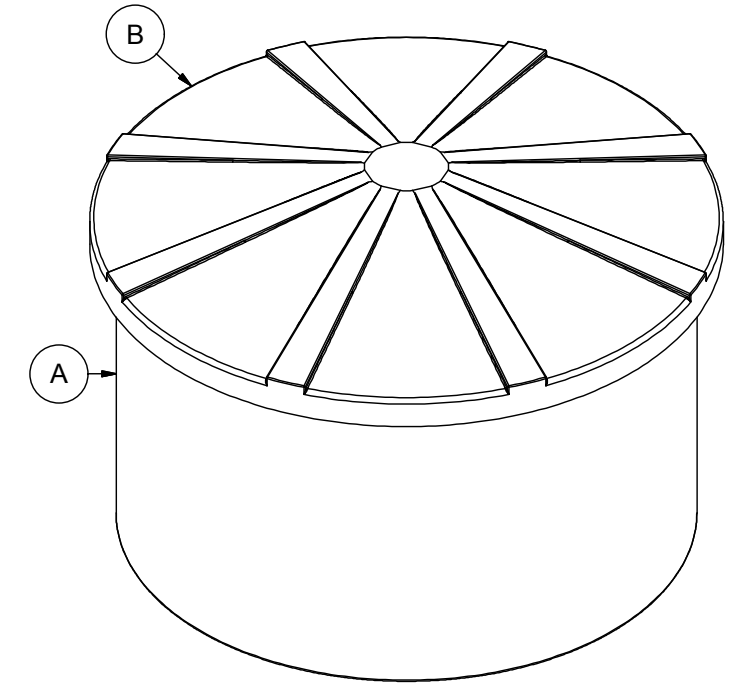
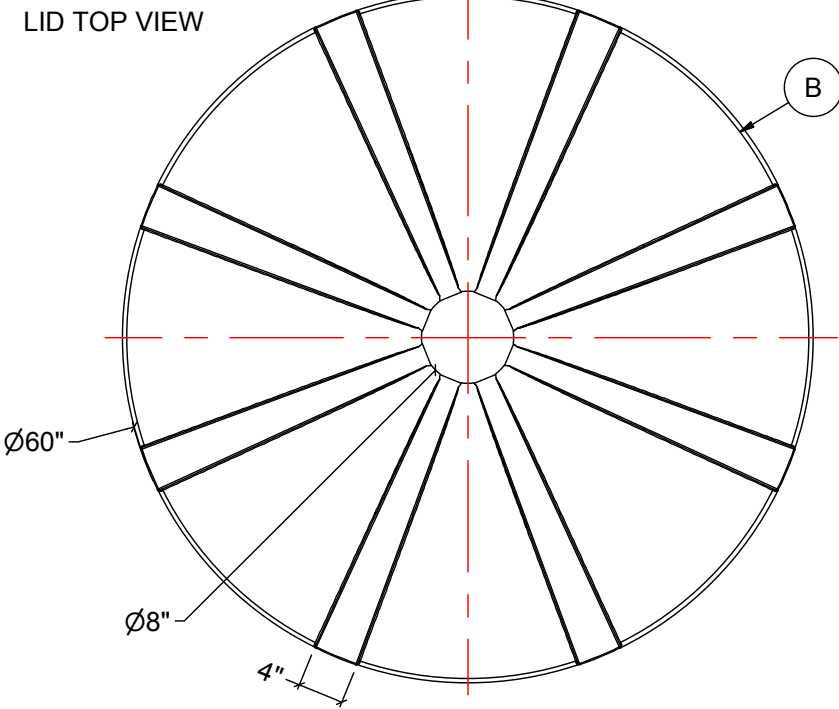
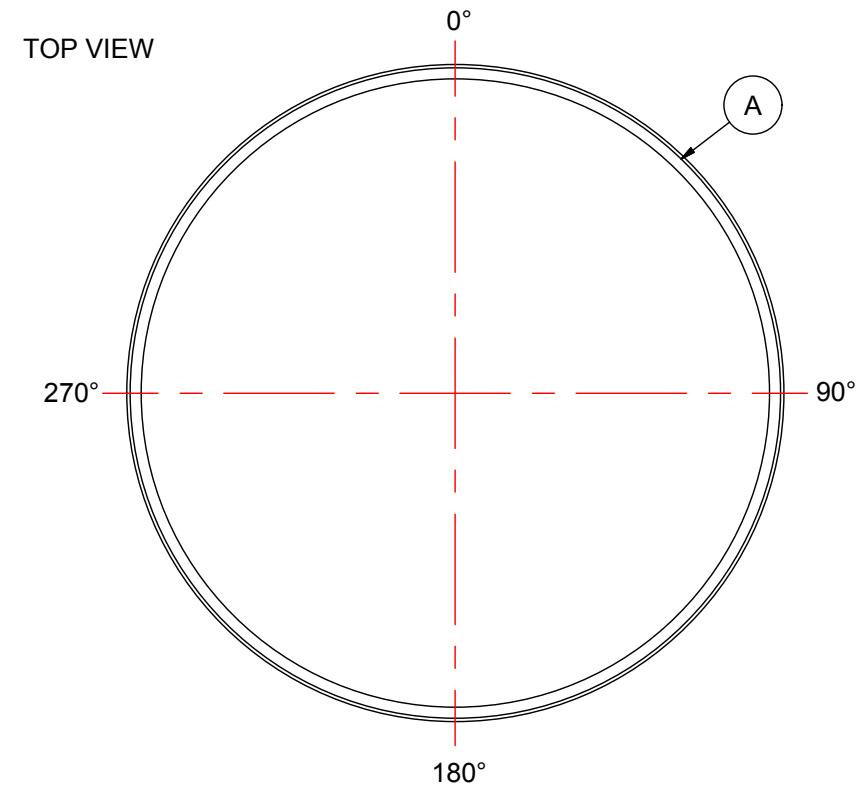

REV	DATE	DESCRIPTION	BY	APPD	REVD
REVISIONS					
CUSTOMER					
TITLE		ACO JOB NO:			
220 IG OPEN TOP TANK		PURCHASE ORDER NO:			
		PURCHASER'S EQUIP. NO:			
THIS DRAWING IS THE PROPERTY OF ROTOPLAST INC. AND SHALL NOT BE COPIED OR TRANSFERRED WITHOUT THE WRITTEN CONSENT OF ROTOPLAST INC.					
ENGINEERS SEAL		ACO CONTAINER SYSTEMS DIVISION OF ROTOPLAST INC.			
<small>PICKERING - ONTARIO - CANADA</small>					
ACO CONTAINER SYSTEMS DIVISION OF ROTOPLAST INC. 794 MCKAY RD. PICKERING, ONTARIO, CANADA TEL. 905-683-8222 FAX 905-683-2969		DESIGNED			
		DRAWN	WM		
		CHECKED			
		APPROVED			
		SCALE	N.T.S.		
DATE		09-03-16			
DWG No		OT-220-L			REV 0