

TOP VIEW

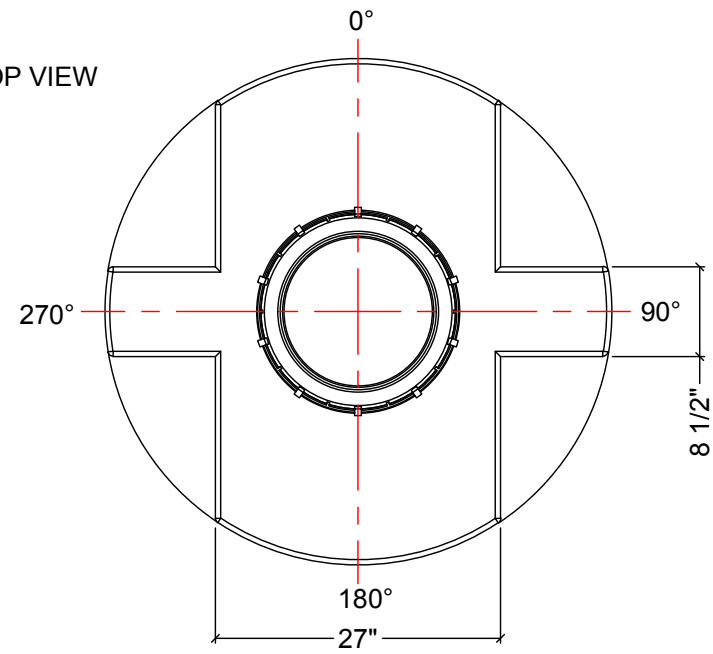

NOTES:

1. TANK IS MANUFACTURED TO ASTM-D-1998 STANDARD.
2. ALL DIMENSIONS ARE APPROXIMATE.

MATERIALS LIST		
ITEMS	DESCRIPTION	NOTES
A	CT-450-CH TANK	
B	16" LID WITH LOCKING STRAP	

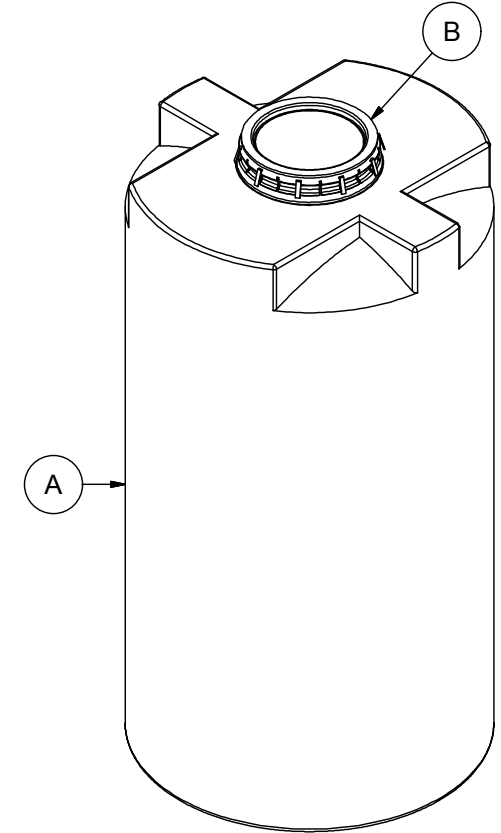
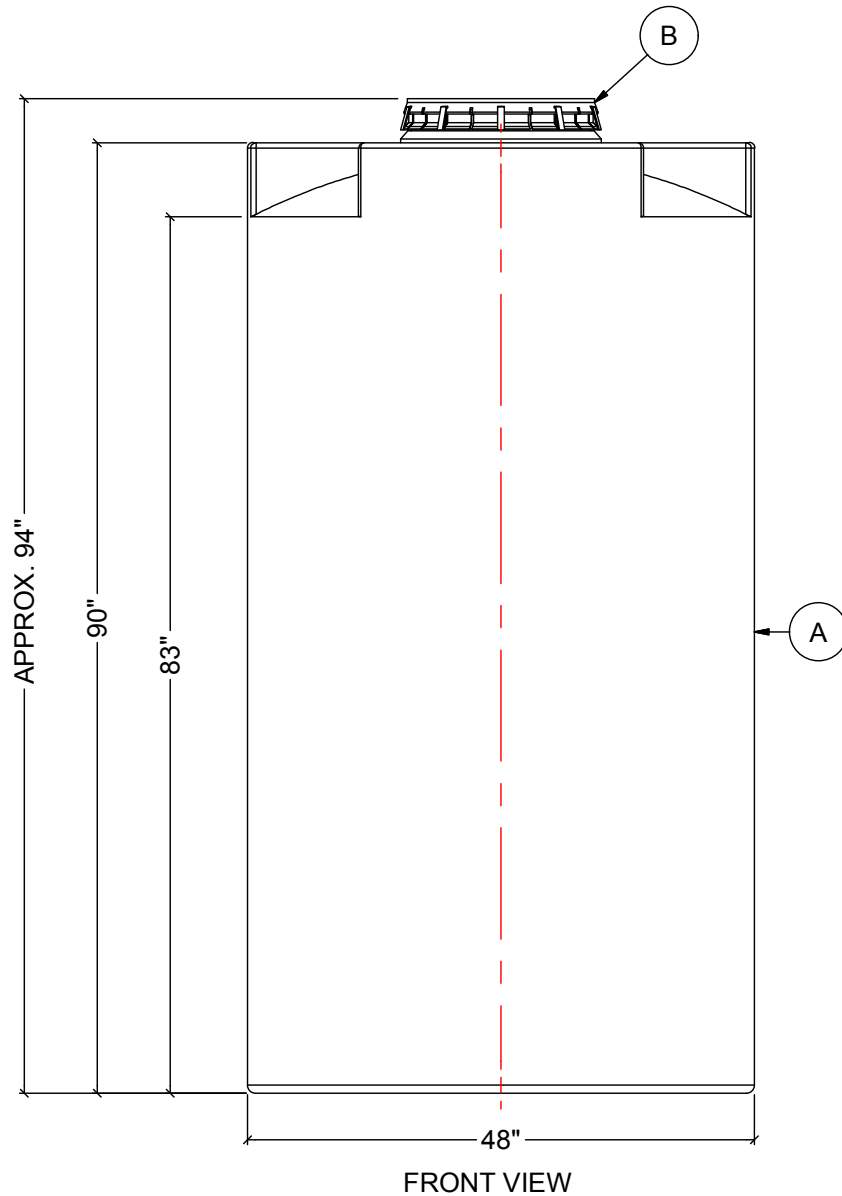

REV	DATE	DESCRIPTION	BY	APPD	REVD
REVISIONS					
CUSTOMER					
TITLE		ACO JOB NO:			
450 IG CLOSED TOP TANK		PURCHASE ORDER NO:			
		PURCHASER'S EQUIP. NO:			
THIS DRAWING IS THE PROPERTY OF ROTOPLAST INC. AND SHALL NOT BE COPIED OR TRANSFERRED WITHOUT THE WRITTEN CONSENT OF ROTOPLAST INC.					
ENGINEERS SEAL		ACO CONTAINER SYSTEMS DIVISION OF ROTOPLAST INC.			
		<small>PICKERING - ONTARIO - CANADA</small>			
		ACO CONTAINER SYSTEMS DIVISION OF ROTOPLAST INC. 794 MCKAY RD. PICKERING, ONTARIO, CANADA TEL. 905-683-8222 FAX 905-683-2969		DESIGNED	
				DRAWN	WM
				CHECKED	
				APPROVED	
				SCALE	N.T.S.
				DATE	02-03-16
		DWG No		CT-450-CH	REV 0