

PLAN VIEW

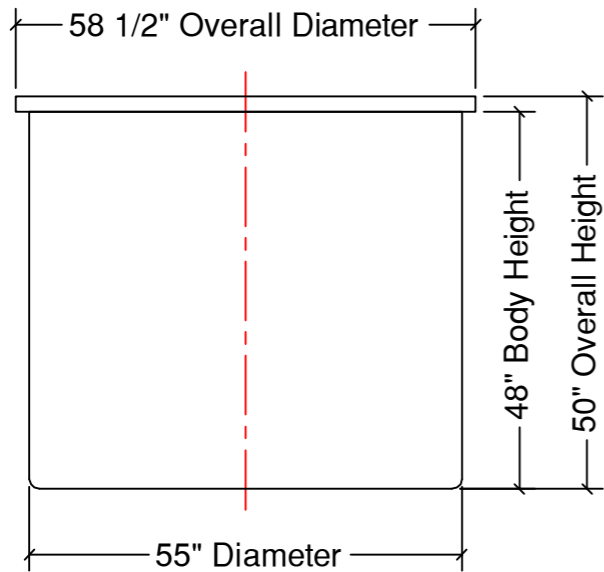

FRONT VIEW

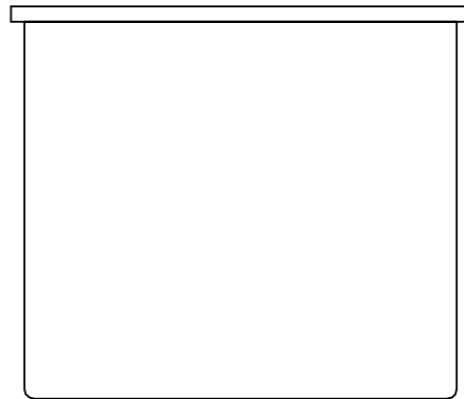

SIDE VIEW

NOZZLE SCHEDULE

ITEM	SIZE	DESCRIPTION	NOTES

NOTES:

- 1. OPTIONAL LID AVAILABLE

REV	DATE	DESCRIPTION	BY	APPD	REVD

REVISIONS

CUSTOMER

TITLE	ACO JOB NO:	-
	PURCHASE ORDER NO:	-
	PURCHASER'S EQUIP. NO:	-

THIS DRAWING IS THE PROPERTY OF ACO CONTAINER SYSTEMS LTD. AND SHALL NOT BE COPIED OR TRANSFERRED WITHOUT THE WRITTEN CONSENT OF ACO CONTAINER SYSTEMS LTD.

ENGINEERS SEAL	ACO CONTAINER SYSTEMS LTD.	
	<small>PICKERING - ONTARIO - CANADA</small>	
ACO CONTAINER SYSTEMS LTD. 794 MCKAY RD. PICKERING, ONTARIO, CANADA L1W 2Y4 TEL. 905-683-8222 FAX 905-683-2969	DESIGNED	S.A.
	DRAWN	J.M.
	CHECKED	
	APPROVED	
	SCALE	N.T.S.
DATE	09-11-06	
DWG No	OT-400	REV 0