

NOTES:

1. TANK IS MANUFACTURED TO ASTM-D-1998 STANDARD.
2. ALL DIMENSIONS ARE APPROXIMATE.

LID TOP VIEW

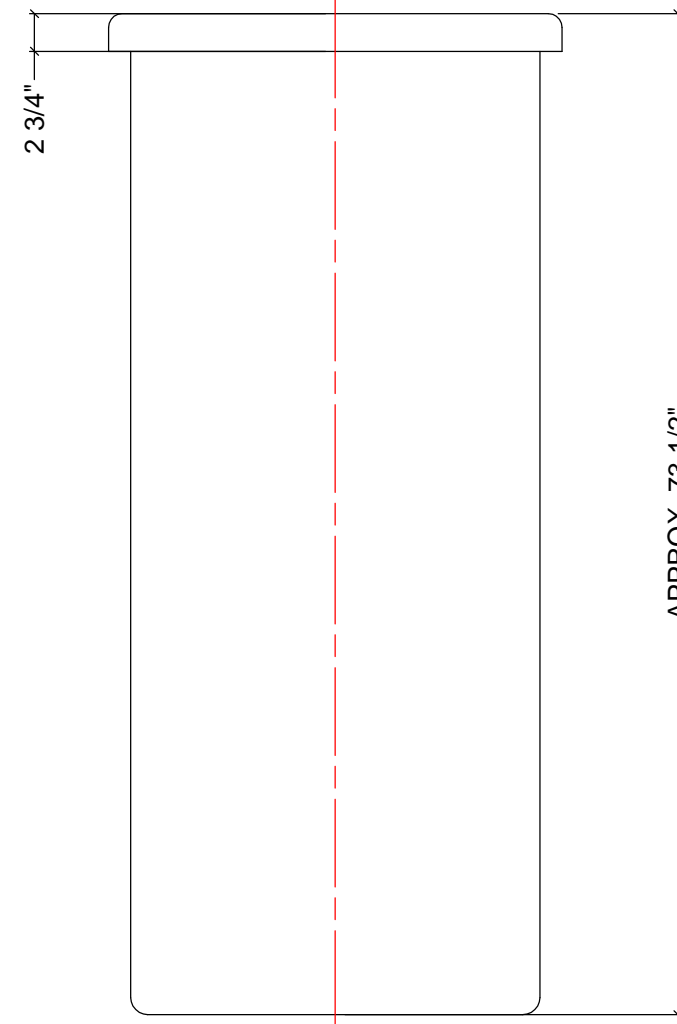
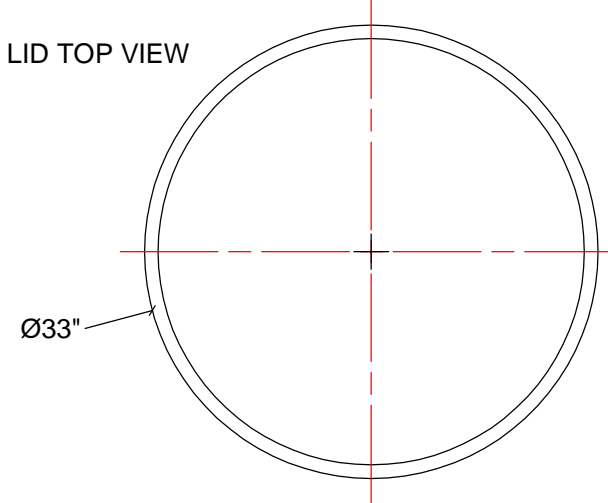

MATERIALS LIST		
ITEMS	DESCRIPTION	NOTES
A	OT-178 OPEN TOP TANK	
B	LID FOR OT-178	

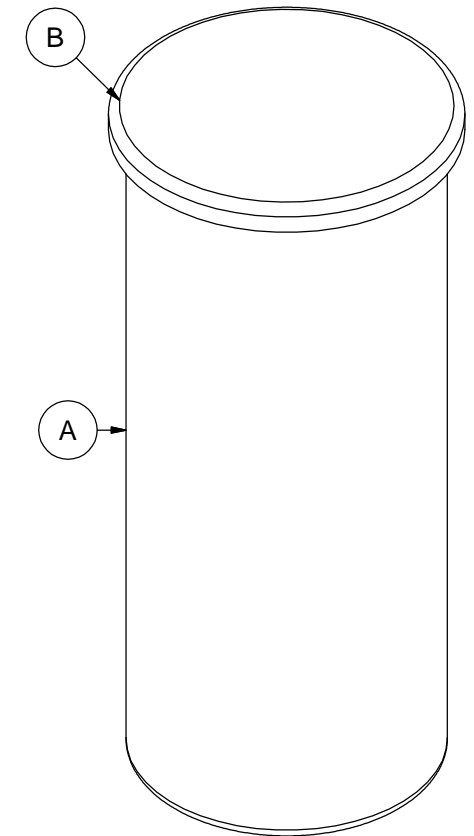

REV	DATE	DESCRIPTION	BY	APPD	REVD
REVISIONS					
CUSTOMER					
TITLE 178 I.G. OPEN TOP TANK WITH LID			ACO JOB NO: PURCHASE ORDER NO: PURCHASER'S EQUIP. NO:		
THIS DRAWING IS THE PROPERTY OF ACO CONTAINER SYSTEMS LTD. AND SHALL NOT BE COPIED OR TRANSFERRED WITHOUT THE WRITTEN CONSENT OF ACO CONTAINER SYSTEMS LTD.					
ENGINEERS SEAL		ACO CONTAINER SYSTEMS LTD.			
ACO CONTAINER SYSTEMS LTD. 794 MCKAY RD. PICKERING, ONTARIO, CANADA L1W 2Y4 TEL. 905-683-8222 FAX 905-683-2969		DESIGNED			
		DRAWN		WM	
		CHECKED			
		APPROVED			
		SCALE		N.T.S.	
		DATE		27-05-09	
DWG No		OT-178-L			REV 0