

NOTES:

1. TANK IS MANUFACTURED TO ASTM-D-1998 STANDARD.
2. ALL DIMENSIONS ARE APPROXIMATE.

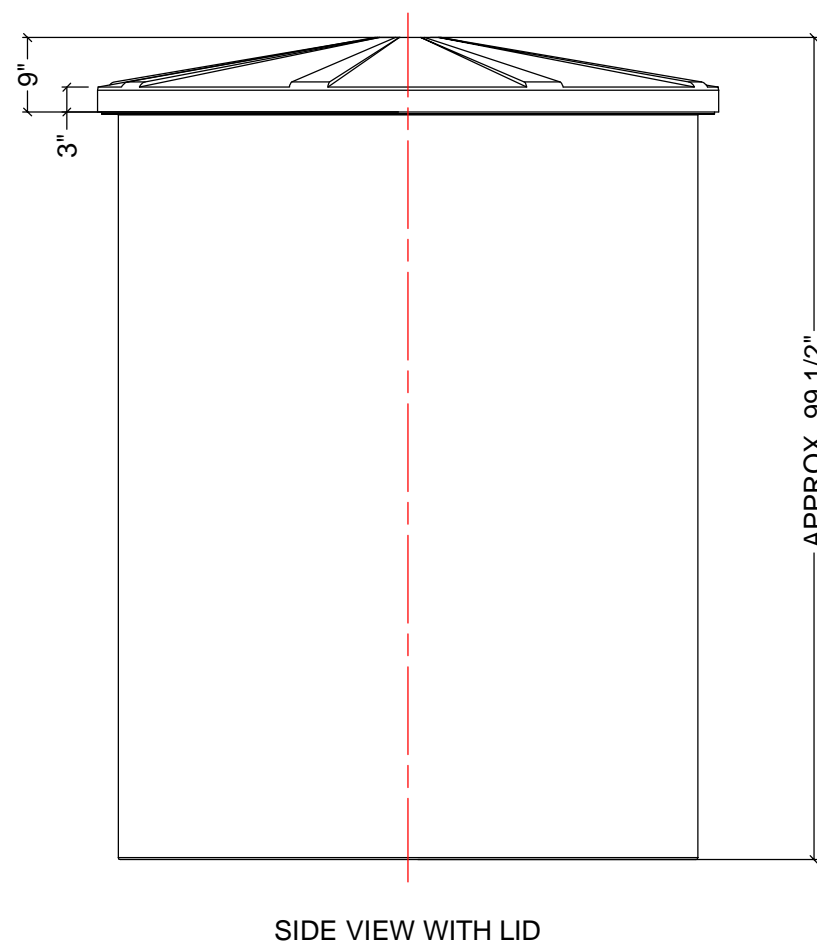

MATERIALS LIST		
ITEMS	DESCRIPTION	NOTES
A	OT-1250 OPEN TOP TANK	
B	LID FOR OT-1250	

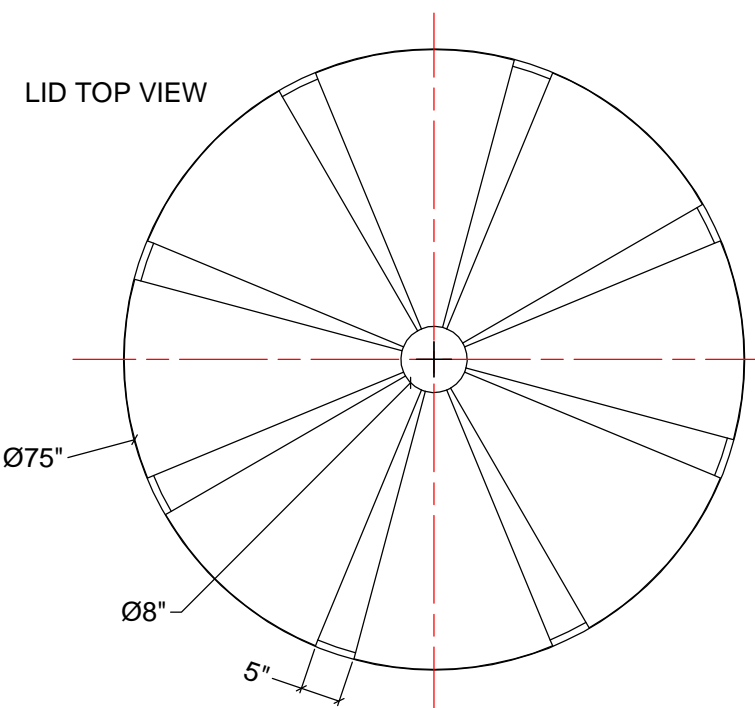
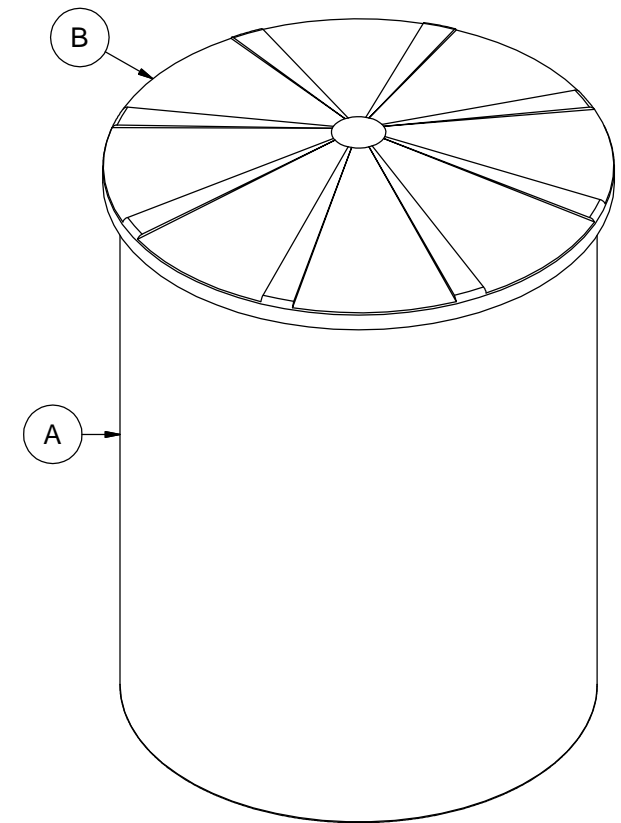

REV	DATE	DESCRIPTION	BY	APPD	REVD	
REVISIONS						
CUSTOMER						
TITLE 1250 I.G. OPEN TOP TANK WITH LID			ACO JOB NO: PURCHASE ORDER NO: PURCHASER'S EQUIP. NO:			
THIS DRAWING IS THE PROPERTY OF ACO CONTAINER SYSTEMS LTD. AND SHALL NOT BE COPIED OR TRANSFERRED WITHOUT THE WRITTEN CONSENT OF ACO CONTAINER SYSTEMS LTD.						
ENGINEERS SEAL		ACO CONTAINER SYSTEMS LTD.				
ACO CONTAINER SYSTEMS LTD. 794 MCKAY RD. PICKERING, ONTARIO, CANADA L1W 2Y4 TEL. 905-683-8222 FAX 905-683-2969		DESIGNED		DRAWN	WM	
		CHECKED		APPROVED		
		SCALE	N.T.S.	DATE	27-05-09	
DWG No		OT-1250-L			REV	0