

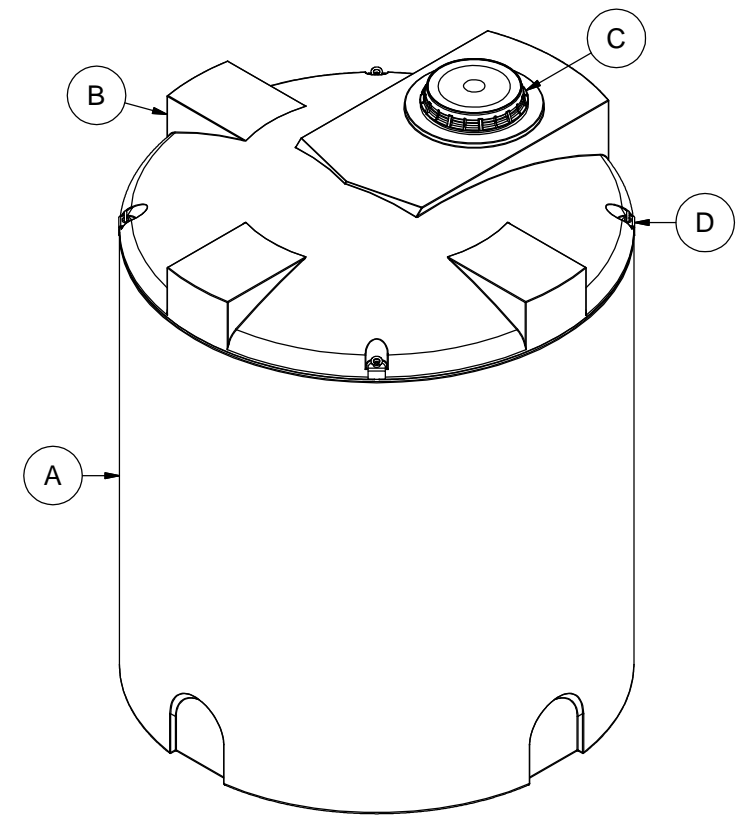

NOTES:

1. TANK IS MANUFACTURED TO ASTM-D-1998 STANDARD.
2. ALL DIMENSIONS ARE APPROXIMATE.

MATERIALS LIST		
ITEMS	DESCRIPTION	NOTES
A	DMT-2100-OUTSIDE	
B	DMT-2100-INSIDE	
C	16" LID WITH LOCKING STRAP (OPTIONAL 21" TREADED LID)	
D	DMT LIFTING LUG ASSEMBLY	4 PLACES

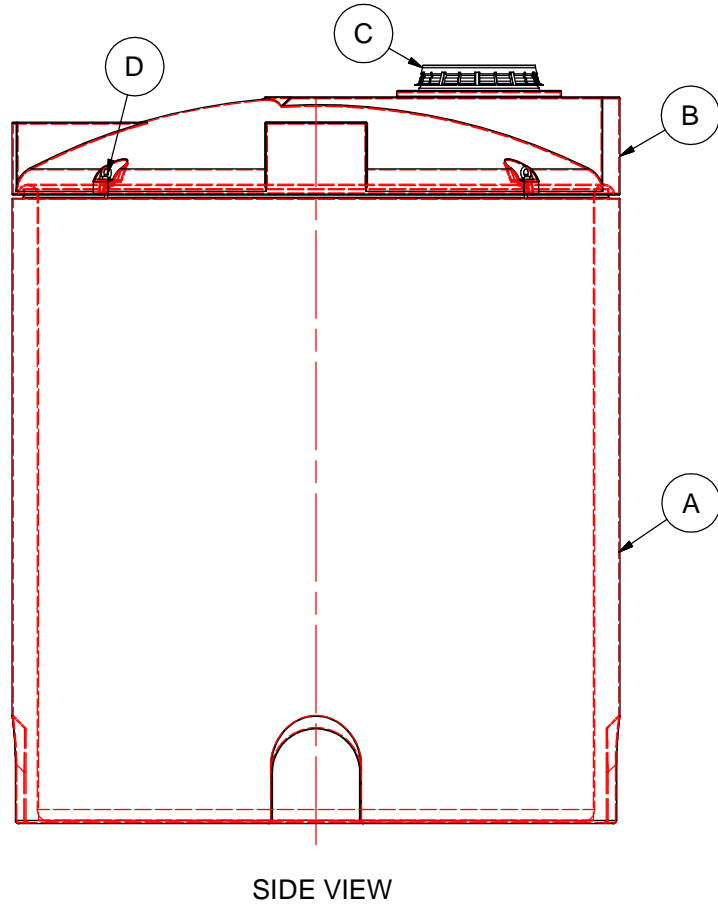
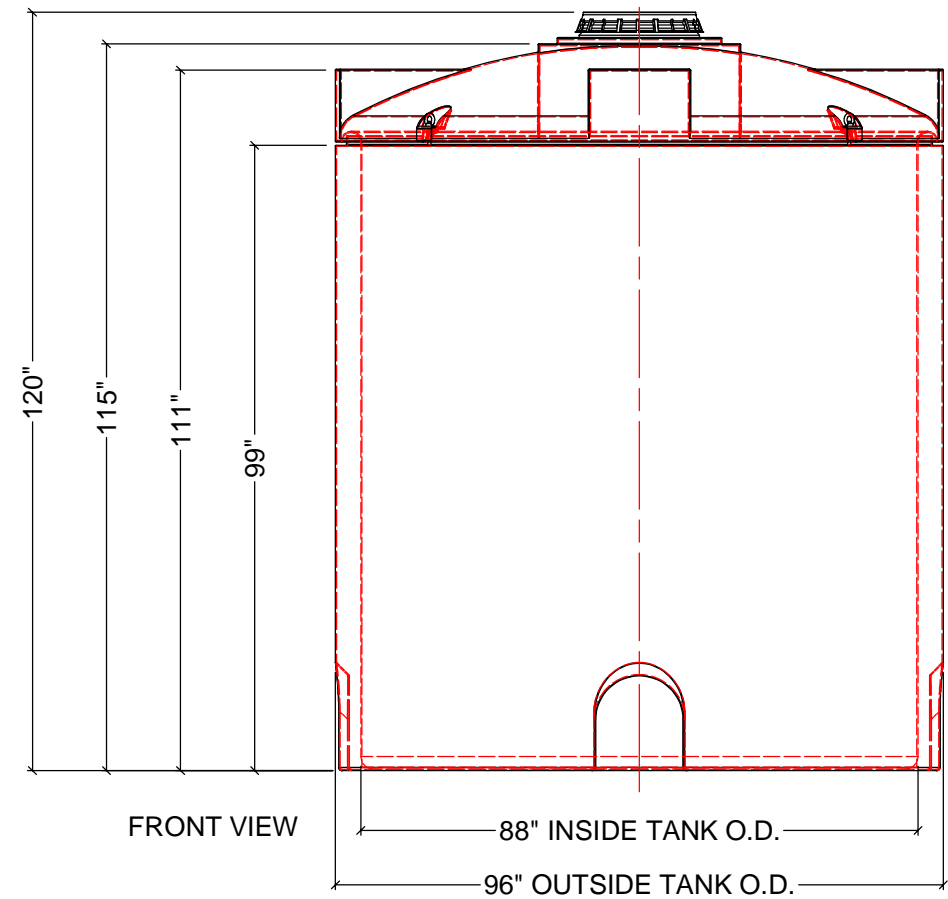

REV	DATE	DESCRIPTION	BY	APPD	REVD
REVISIONS					
CUSTOMER					
TITLE 2100 I.G. DOUBLE WALL TANK			ACO JOB NO: PURCHASE ORDER NO: PURCHASER'S EQUIP. NO:		
THIS DRAWING IS THE PROPERTY OF ACO CONTAINER SYSTEMS LTD. AND SHALL NOT BE COPIED OR TRANSFERRED WITHOUT THE WRITTEN CONSENT OF ACO CONTAINER SYSTEMS LTD.					
ENGINEERS SEAL			ACO CONTAINER SYSTEMS LTD.		
PICKERING - ONTARIO - CANADA ACO CONTAINER SYSTEMS LTD. 794 MCKAY RD. PICKERING, ONTARIO, CANADA L1W 2Y4 TEL. 905-683-8222 FAX 905-683-2969			DESIGNED	WM	
			DRAWN		
			CHECKED		
			APPROVED		
			SCALE	N.T.S.	
			DATE	20-05-09	
DWG No			DMT-2100		REV 0